

Test Procedure
for
Conducted Energy Weapons

Version 2.0

2017/02/17

Contents

	Page
0.0 Disclaimer	1
1.0 Foreword	2
2.0 Introduction	3
3.0 Test Equipment	5
4.0 General Procedure	6
5.0 Specific Procedure	6
6.0 Data Analysis	8
7.0 Sample Report Format	11
8.0 Acknowledgements	12
9.0 Bibliography	13

Appendices

Appendix A	TASER M26	14
Appendix B	TASER X26E, X26	24
Appendix C	TASER X26P, X2	34

Test Procedure for Conducted Energy Weapons

0.0 Disclaimer

The persons referred to as “Authors” herein include the following list of individuals and their organizations: Andy Adler (Carleton University), Dave Dawson (Carleton University, and Ian Sinclair (MPB Technologies). The term “implementers” includes all individuals and organizations which choose to implement any or all of the recommendations in this paper.

0.1 Limited Purpose

The Authors prepared this paper for a readership limited to test personnel and their employer organizations (“Readers”). The purpose of the paper is to assist the Readers by providing a set of recommendations intended to allow Readers to carry out tests on Conducted Energy Weapons (“CEWs”) in a controlled and repeatable manner across jurisdictions. The consistent application of the recommendations may enable Readers to establish that they have followed consistent procedures to determine that their CEWs are performing within specification at time of test. The consistent application of the recommendations may also enable the collection of uniform data to allow future assessment of any trends in performance.

0.2 No Warranty

This paper is provided on the terms “As Is, Where Is”, and the Authors give no warranty or representation of any kind whatsoever as to the appropriate policies for the use of, nor the safety of the use of CEWs. The Authors expressly disclaim all express or implied warranties relating to the contents of the paper. The Authors give no warranty or representation of any kind whatsoever that the recommendations contained in this report are comprehensive. The Authors give no warranty or representation of any kind whatsoever that the recommendations are up to date beyond the date on which the paper is published.

0.3 Working Paper Only

This paper is a “working paper” meaning that it reflects the knowledge of the Authors relating to the procedures for testing of CEWs as at the time the paper is written, without any commitment to update or revise the paper.

0.4 Implementer Responsibility

The Implementer acknowledges and agrees that it is possible and probable that new developments will give rise to a need for new testing limits and it is incumbent upon the Implementer to ensure that he/she understands that the paper is up to date to the knowledge of the Authors, only to the time it is written. The Implementer understands and accepts exclusive liability for the decision to rely on the paper and the decision to implement some or all of the recommendations.

0.5 Implementer Indemnifies Authors

THE IMPLEMENTER SHALL INDEMNIFY AND SAVE THE AUTHORS HARMLESS FROM AND AGAINST ANY CLAIMS, LIABILITY OR COST (INCLUDING LEGAL COSTS) TO WHICH THE AUTHORS MAY BE SUBJECT OR THAT MAY BE BROUGHT AGAINST THE AUTHORS BY REASON OF THE IMPLEMENTER’S DECISION TO IMPLEMENT ANY OR ALL OF THE RECOMMENDATIONS IN THE PAPER.

1.0 Foreword

Several studies including the Braidwood Commission report⁴, the Report of the Standing Committee on Public Safety and National Security of the Conducted Energy Weapon⁶, the report of the Commission for Public Complaints against the RCMP⁷ and other provincial reports and coroners' recommendations have discussed the need for reliable uniform testing of Conducted Energy Weapons (CEWs) independent of the manufacturer.

This Test Procedure will enable organizations across Canada to test CEWs in a reliable, repeatable manner to determine whether they are operating within manufacturer's specifications. Test results so obtained will be usable in various ways.

- The CEW inventory of a given police service can be tested on acceptance and regularly thereafter to ensure all issued weapons are functioning as intended.
- Any CEW involved in an incident resulting in personal injury will be able to be tested after the incident to reliably determine its operating parameters.
- All data collected from weapons tests across Canada will be known to be reliable and comparable. As a result, new data will be able to be added to the growing body of knowledge concerning CEW operation over time so that future research may be able to determine trends in age or other factor related changes in performance

This document contains a set of recommendations for measurement of the performance characteristics of conducted energy weapons. It represents the opinions of its authors (Section 8.0), a group of subject matter experts who have been involved in research on or testing of CEWs, and is subject to the disclaimer presented in 0.0.

None of the authors has any financial or personal interest in TASER International or any other CEW manufacturer. Several of the authors have discussed weapons testing with staff from TASER International.

The authors grant permission to copy, distribute, and adapt this work on the condition that the adapted work cites this document (under the creative commons attribution licence). This work may be cited as:

Andy Adler, David Dawson, Ian Sinclair, "Test Procedure for Conducted Energy Weapons, Version 2.0", 2017-02-17, DOI: 10.22215/cewtp2017

It is available online via: <http://dx.doi.org/10.22215/cewtp2017>
<https://curve.carleton.ca/CEWCollection/CEWTest-Procedure-2017-ver2.0.html>

2.0 Introduction

2.1 Purpose

The CEW Test Procedure:

- Establishes a methodology by which testing facilities and personnel across Canada will be able to test CEWs and determine whether they are operating within manufacturers' specifications,
- Defines data collection requirements so that data collected during the testing of any CEW in Canada may be used in forensic analysis of that weapon and may also be added to a central data base for future research and data mining programs,

2.2 Scope

This Test Procedure is meant for use with Conducted Energy Weapons that have the following characteristics:

- They are hand held
- They use a pulse or pulse train to deliver electrical energy to the target
- They are meant to function by causing temporary human electro-muscular incapacitation

2.3 Revision Log

Version	Date	Modifications
1,0	2010-07-08	Initial Release
1,1	2010-07-31	Added monophasic charge parameter
2.0	2017-02-17	Addition of X2 and X26P in new Appendix C. Section 3.3: Altered sampling rate, trigger settings. Section 3.8: Added requirement for gap for X2 testing Added Section 3.9 Bibliography Clarified definition of Net Charge for different units.

2.3 Definitions

Pulse	A short discharge of electrical energy
Peak Voltage	Peak of the voltage waveform for the pulse
Peak Current	Peak of the current waveform for the pulse
Net Charge	The integral of the value of the current waveform for a specified portion of the pulse
Monophasic Charge	The maximum of the absolute values of A and B, where A = the integral of all positive current in a pulse, and B = the integral of all negative current in a pulse.
Total Charge	The integral of the absolute value of the current waveform for the full pulse duration
Burst Length	Time from the first pulse to the last pulse for a single firing of the CEW
Pulse Duration	The time between the sample points at which the voltage waveform crosses through a specified start point voltage to a specified end point voltage.
Pulse Repetition Rate	For an interval which contains N pulses, the Pulse Repetition Rate is (N-1) divided by the time from the first to last pulse.

Detailed descriptions and values for these parameters are included in the appendices for specific models of CEW.

3.0 Test Equipment

3.1 Introduction

The equipment required for the electrical testing is listed in this section.

3.2 Calibration

All test equipment must be calibrated yearly to national standards.

3.3 Data Acquisition and Storage System

- Minimum resolution of 1% of the maximum specified voltage (Section 10 of Appendices)
- Minimum bandwidth of 10 MHz and sampling rate of 5 MSamples/s or sufficient to achieve at least 1% maximum voltage sampling error as per good engineering practice.
- Anti-aliasing low pass filter (5 MHz) in accordance with good engineering practice
- Minimum 8 bit digitization of stored sample data
- Sufficient storage capacity to record all pulses
- Adequate pretrigger interval if pulse triggering is used
- The data acquisition system shall either: 1) capture the entire data stream, or 2) have a trigger setting to capture all pulses which exceed ± 50 V amplitude.

3.4 Voltage Probe

- Voltage reduction probe (e.g. 1000:1)
- Minimum 10kV rating

AND/OR

3.5 Current Probe

- Suitable for ranges to 30 A

3.6 Resistive Load

- Pure resistance (low reactance, non-inductive) at 100 kHz.
 - Note: wire wound resistors are not generally acceptable.
- 10 W power rating
- Value specified in appendices for specific models of CEW.

3.7 Connecting wires

- Should be as large a gauge as practical in order to minimize impedance
- Should be kept as short as possible

3.8 Mounting Jig

- A jig or other mounting method is required to stabilize the weapon and allow hands-off operation during test. It will typically employ a spent cartridge. (Note 1)
- The mounting jig is required to have a spark gap equivalent to the tested scenario.
- For M26/X26E/X26P cartridges, the spark gap is part of the cartridge.
- For the X2, the spark gap is external to the cartridge and is normally provided by the distance to the wires⁵. A suitable gap should be part of the jig for the X2.

3.9 Insulating Surface

- The test set up should be mounted on an insulating surface to ensure protection of the test staff from electrical discharge.

Note 1: A mechanical/electrical system equivalent to a spent cartridge may be used. If so, it must include a housing designed to firmly hold the weapon and expose it to equivalent electrical connections and spark gap as would be seen with a spent cartridge.

4.0 General Procedure

4.1 Initial Inspection

Carry out a visual inspection of the weapon prior to testing. If there are obvious physical deficiencies such as poor fitting of the battery pack or safety and trigger switches, do not proceed with the electrical testing.

4.2 Measurement

Acquire and store relevant data from full bursts except where noted. Obtain quantitative data on

- Peak Voltage (measured directly or calculated by measuring the peak current and multiplying by the load resistance)
- Peak Current (measured directly or calculated by measuring the peak voltage and dividing by the load resistance).
- Net Charge (derived from the current pulse; the portion of the pulse over which Net Charge is calculated is specific to the CEW under test; see the relevant appendix.)
- Total Charge
- Monophasic Charge
- Pulse Duration
- Pulse Repetition Rate.

4.3 Analysis

Determine if the CEW is In Tolerance or Out of Tolerance by comparison of measured values with specifications.

5.0 Specific Procedure

5.1 Introduction

This procedure gives test set up, conduct and analysis methodology. Detailed test equipment operating procedures have not been provided, but have been described elsewhere^{5,8}. Good engineering practice, proper laboratory processes and familiarity with laboratory measurement equipment is expected. Detailed quantitative data for determining compliance with manufacturer's specifications are given in the appendices for specific models of CEW.

5.2 Initial Inspection

Prior to beginning testing, record the following

- Manufacturer of the test weapon
- Model number and Serial number
- Battery model and serial number (if available without opening unit under test)
- Battery capacity (if available without opening unit under test)
- Software version installed (if available without opening unit under test)
- Temperature, humidity and atmospheric pressure of the test environment

CAUTION: High voltages will be present during the test. Exercise caution in the layout of the equipment and conduct of the test to avoid exposure to the high voltage.

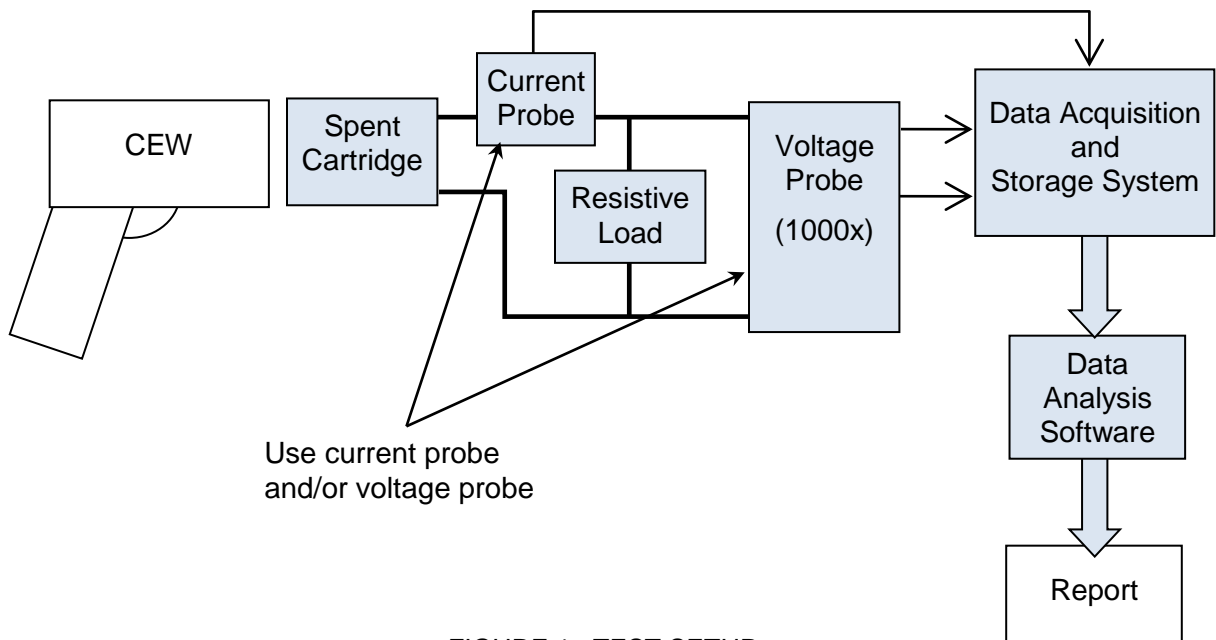

FIGURE 1: TEST SETUP

5.3 Measurement

5.3.1 Setup

- Set up the test equipment on the insulating surface.
- Select a sampling rate on the Data Acquisition System of 5 MSamples/s or greater.
- Connect the probe(s) to the test apparatus:
 - connect the high voltage probe across the test load.
 - AND/OR
 - place the current probe around the appropriate lead from the weapon to the load.
- Connect the probe leads to the Data Acquisition System
- Prepare the weapon for test by stabilizing it with a spent cartridge. (Note 1, Note 2)
- Set up the weapon in the test jig or similar apparatus to allow hands-off support.

5.3.2 Test

- Connect the weapon across the test load. (Note 3)
- Pull the trigger on the weapon to initiate the burst.
- Allow the weapon to fire for the full duration of the burst.
- Verify that all data has been acquired and stored.
- Fire the weapon two more times and record the data. (Note 4)
- Verify data has been acquired and stored.
- Identify the data records with the serial number of the weapon under test.

Note 2: Repeated use of the spent cartridge will result in build up of deposits due to arcing. Inspect and clean the cartridge regularly.

Note 3: We consider the test loads recommended by TASER International (600 Ohm for the X26/X26P/X2 and 500 Ohm for the M26) to be an adequate model of the impedance load of the body. These CEWs behave largely as a current source and have relatively little variation in charge with load. Savard et al¹¹, found a variation of approximately 25% from the average current across loads below 1000 Ohm. Such variation may be accounted for by the safety factor

Note 4: The full procedure with three weapon firings is meant to collect additional data for future data mining. This should be used for acceptance testing and regularly scheduled maintenance testing. For users wishing to conduct daily testing, only two firings are required in order to determine weapon compliance with manufacturer's specifications.

6.0 Data Analysis

6.1 Data Analysis Software

Tests may be run most efficiently with data analysis software. (Note 5)

6.2 Parameters averaged over the last second of the burst

The software will determine the following from pulses that fit into the last second of the burst during the first firing of the weapon:

- Pulse Repetition Rate

6.3 Parameters averaged over the last 8 pulses

The analysis software will also determine the following by averaging data from the last 8 pulses recorded for the second firing of the weapon:

- Peak Voltage
- Peak Current
- Net Charge (Note 6)
- Pulse Duration

6.4 CEW status as per manufacturer specifications

All of the previous five values are required in order to determine whether operation of the weapon is within manufacturer's specifications. Compare the output of the analysis software with the manufacturer's specifications given in the appendix. Determine for each of the parameters whether the weapon's performance was,

- Above Tolerance
- In Tolerance
- Below Tolerance

6.5 Within Specification

If all five parameters are In Tolerance, then the weapon may be reported as having performed within manufacturer's specifications. (Note 7)

6.6 Charge Measurements

The analysis software will determine the following for each pulse in each of the three firings of the weapon:

- Monophasic Charge
- Total Charge

CEWs with Monophasic Charge for any individual pulse in excess of the value listed in the corresponding appendix should be declared Out of Tolerance (Note 8).

6.7 Parameter Statistics over the burst

The software should calculate and store, for each of the seven parameters listed (Pulse Repetition Rate, Peak Voltage, Peak Current, Net Charge, Pulse Duration, Monophasic Charge and Total Charge) the value for each pulse for each firing.

In addition, the maximum, minimum and average of each parameter for all pulses in each of the three firings should be calculated and stored. Note that the average pulse repetition rate is the pulse repetition rate for the burst length, and not the average of the pulse repetition rates for each pulse in the burst.

Note 5: An implementation of the analysis software has been created by Carleton University. This software may be used in the analysis of the stored data. It is available under an open-source license (Adler et al, 2011³).

Note 6: The appropriate period over which *Net charge* is calculated varies with CEW model. For clarity, this document provides specific terminology for each calculation. For the M26, the *Strike Phase Net Charge* is used; for the X26/X26E, the *Main Phase Net Charge* is used; for the X26P/X2, the *Full Pulse Net Charge* is used. See the corresponding appendices for details.

Note 7: If a weapon performs out of tolerance, replacement of the batteries or Digital Power Module may bring the weapon to within expected performance. Note that for some weapons, introduction of a new DPM may introduce new operating software, which will create an

essentially new configuration for the weapon. This procedure should only be carried out if prior agreement on this policy has been established with the owner of the weapon and, in any event, a complete test series should be repeated on the new weapon/power system combination and reported as a separate test with a separate test report.

Note 8: There is no specification which applies exactly to the waveforms of complex CEW discharges. In our opinion, the most relevant specification is that of IEC TS 60479 Part 2 (Section 11) which considers the “effects of unidirectional single impulse currents of short durations” (0.1 ms and above). This section of the specification defines curves based on the “probability of fibrillation risk for current flowing through the body from the left hand to both feet”. We base our calculation on the “C1 curve” which is defined as “no risk of fibrillation”⁹. For a 0.1 ms pulse, this is equivalent to a 710 μC charge. To account for differences in body size and placement of stimulation electrodes, we recommend an additional safety factor of four be imposed, so the maximum allowable value for any individual stimulating pulse would be the value listed in the corresponding appendix for specific models of CEW. Since CEW waveforms are not unidirectional, two possible parameters may be compared to the IEC 60479-2 based threshold: 1) Total Charge, or 2) Monophasic Charge. Total Charge is a more conservative measure, however, Monophasic Charge may be justified based on physiological models such as Reilly et al¹⁰. Based on our understanding of the current literature, Monophasic Charge is the appropriate measure².

7.0 Sample Report Format

7.1 Report Format

The following report format is presented as a sample which shows all of the relevant information collected during testing. Comments in Line 7 could include, for example, notes on the operation of the CEW display or on its general appearance or on obvious discrepancies in the operation of the device itself.

Conducted Energy Weapon Test Report	Date:
Weapon: (mfr and model)	Serial Number:
Police Service:	Police Officer:
Test Service:	Tester:

Visual Inspection	Case <input type="checkbox"/> Battery <input type="checkbox"/> Electrodes <input type="checkbox"/>
Data Download Performed	<input type="checkbox"/>
Comments	
Software Version	
Battery Charge	
Battery Model and Serial	
Temperature	
Humidity	
Atmospheric Pressure	

	Max			Min			Avg			Avg-TI		
	1	2	3	1	2	3	1	2	3	1	2	3
Firing No												
Peak Voltage (V)												
Peak Current (A)												
Net Charge (µC)												
Pulse Duration (µs)												
Pulse Rep Rate (P/s)												
Monophasic Charge (µC)												
Total Charge (µC)												
Burst Length (s)												

Within Specifications: Yes / No

Note: The "Net Charge" definition for the weapon under test should be used (Note 6).

7.2 Data Protection

If an electronic report is used, care should be taken to electronically protect the data from corruption. Digital signatures or encryption may be employed.

8.0 Acknowledgements

This Test Procedure was developed as a result of an initiative spearheaded by Carleton University, Systems and Computer Engineering who organized workshops on the topic of CEWs with partial funding from Public Safety Canada and the Canadian Police Research Centre (CPRC). These workshops brought together a wide range of participants with experience in the field to discuss concerns around the use of these weapons and to develop suggestions for a way forward.

The group which put together this version of this document included the following participants:

Dr. Andy Adler, Carleton University

Mr. Dave Dawson, Carleton University

Dr. Ian Sinclair, MPB Technologies (with thanks also for the contents of Appendices A and B which were based on his publications of Test Concepts for the TASER M26 and X26)

The previous version of this document (version 1.1, 2010-07-31)¹ included the following participants:

Mr. Ron Evans, Datrend Systems Inc.

Mr. Laurin Garland, Vernac Ltd.

Mr. Mark Miller, Datrend Systems Inc.

9.0 Bibliography

- ¹ A Adler, D Dawson, R Evans, L Garland, M Miller, I Sinclair, "Test Procedure for Conducted Energy Weapons Version 1.1", 2010-07-31, <http://curve.carleton.ca/papers/2010/CEW-Test-Procedure-2010-ver1.1.pdf>
- ² A Adler, D Dawson, R Evans, L Garland, M Miller, I Sinclair, R Youmaran, "Toward a Test Protocol for Conducted Energy Weapons" *Modern Instrumentation*, 2(1):5-7, January 2013 DOI:10.4236/mi.2013.21002
- ³ A Adler, O Marsh, DP Dawson, "Documentation of the Carleton University Conducted Energy Weapons (CEW) Test Analysis Software", Defence R&D Canada – Centre for Security Science Contract Report, DRDC CSS CR 2011-18, October 2011, http://cradpdf.drdc-rddc.gc.ca/PDFS/unc114/p535480_A1b.pdf
- ⁴ TR Braidwood. "Why? The Robert Dziekanski Tragedy". Braidwood Commission on the Death of Robert Dziekanski. British Columbia, May 2, 2010. <http://www2.gov.bc.ca/assets/gov/law-crime-and-justice/about-bc-justice-system/inquiries/braidwoodphase2report.pdf>
- ⁵ JR Bray, F Cameron, "Electrical Testing of TASER X2 and TASER X26P Conducted Energy Weapons", DRDC-RDDC-2014-C116, especially Section 3.4 "Adapters and Test Leads". cradpdf.drdc-rddc.gc.ca/PDFS/unc200/p800111_A1b.pdf
- ⁶ G Breikreuz. Study of the Conductive Energy Weapon – TASER. Report of the Standing Committee on Public Safety and National Security, 39th Parliament, 2nd Session. June 2008. <https://www.publicsafety.gc.ca/lbrr/archives/cn75434829-eng.pdf>
- ⁷ Commission for Public Complaints Against the RCMP. 2008-2009 Annual Report. Section "CPC Reports and Findings: RCMP Conducted Energy Weapon (TASER (R) Use. <https://www.cccc-cctcp.gc.ca/pdf/CPC-AR08-09-eng.pdf>
- ⁸ DP Dawson, Y Maimaitijiang, A Adler. "Development of a Performance Calibration System for X-26 TASERs". International Workshop on Medical Measurement and Applications (MeMeA), Ottawa, Apr 30 – May 1, 2010
- ⁹ IEC/TS 60479-2:2007, "Effects of current on human beings and livestock – Part 2: Special Effects", Figure 20, "Threshold of ventricular fibrillation".
- ¹⁰ JP Reilly, AM Diamant and J Comeaux. Dosimetry considerations for electrical stun devices. *Physics in Medicine and Biology*, 54 (2009) 1319-1335. <http://iopscience.iop.org/0031-9155/54/5/015>
- ¹¹ P Savard, R Walter, A Dennis, "Analysis of the Quality and Safety of the Taser X26 devices tested for Radio-Canada / Canadian Broadcasting Corporation by National Technical Systems, Test Report 41196-08.SRC", Dec 2, 2008, <http://www.cbc.ca/news/pdf/taser-analysis-v1.5.pdf>

Appendix A
Detailed Specifications
TASER M26

Appendix A

Detailed Specifications

TASER M26

A.1 Introduction

This appendix gives details of the waveform, definitions and specifications for the parameters of interest for the TASER M26. The parameters of interest are based on

A.2 Pulse Waveform

The TASER M26 pulse consists of a damped oscillation with a $17 \mu\text{s}$ time constant. The initial half sinusoid is known as the "Strike Phase" as shown in Figure A1. The pulses are delivered in a burst as shown in Figure A2. The burst consists of about 75 pulses over 5 seconds, at the rate of 15 pulses per second if an alkaline battery is used. The burst has 100 pulses at the rate of 20 pulses per second if a NiMH battery is used.

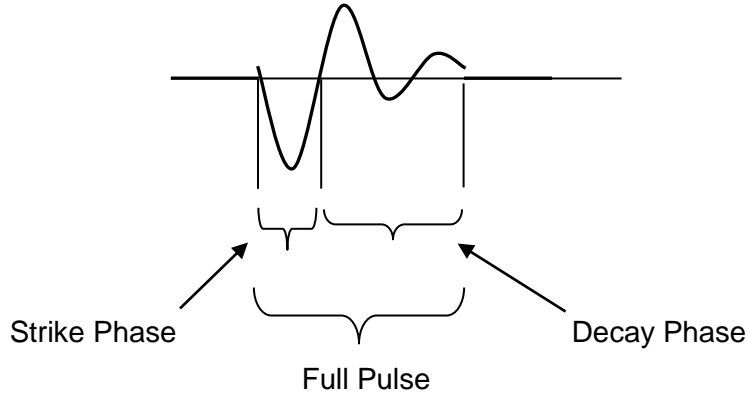

FIGURE A1: PULSE, CONSISTING OF STRIKE PHASE AND DECAY PHASE

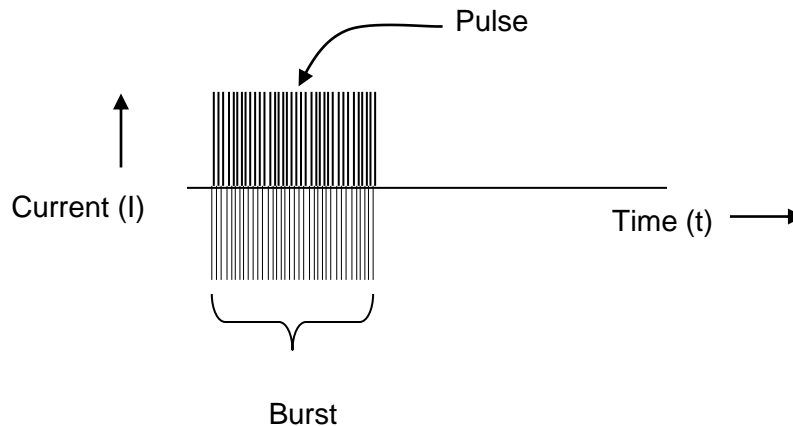

FIGURE A2: BURST OF APPROXIMATELY 75 OR 100 PULSES

A.3 Parameters of Interest

Information is derived primarily from the Strike Phase, since this is the pulse that captures the motor neuron. It is 10 μs long, and delivers about 100 μC of charge in a single direction, whereas the remainder of the pulse delivers about 100 μC spread over 40 μs in alternating negative and positive directions.

Some plots show the Strike Phase above the axis, some show it below the axis (Figure A3). This is merely a question of how the load is connected to the scope. Either orientation of the pulse shows the same thing.

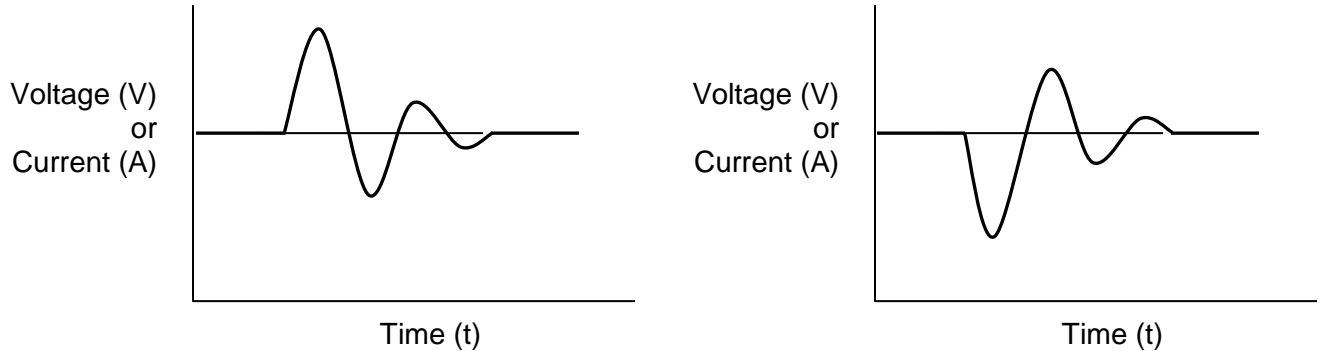

FIGURE A3: M26 PULSE INVERSIONS

Parameters of individual M26 pulses will be calculated as shown in Figure A4 to Figure A8. These describe, respectively,

- peak voltage (strike phase)
- peak current (strike phase)
- net charge (strike phase)
- pulse duration (full pulse),
- pulse repetition rate
- Monophasic Charge
- Total Charge

For the M26, the *Net Charge* is to be calculated over the *Strike Phase*. This parameter is also known as the *Strike Phase Net Charge*. (See Section A.5.)

A.4 Peak Voltage and Peak Current

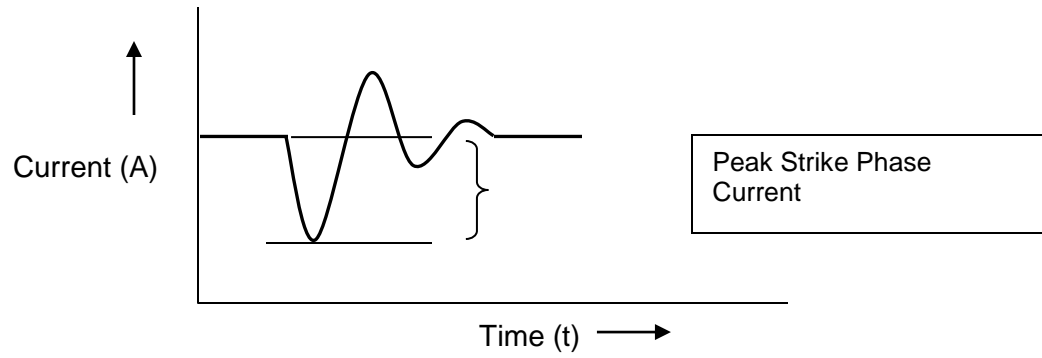
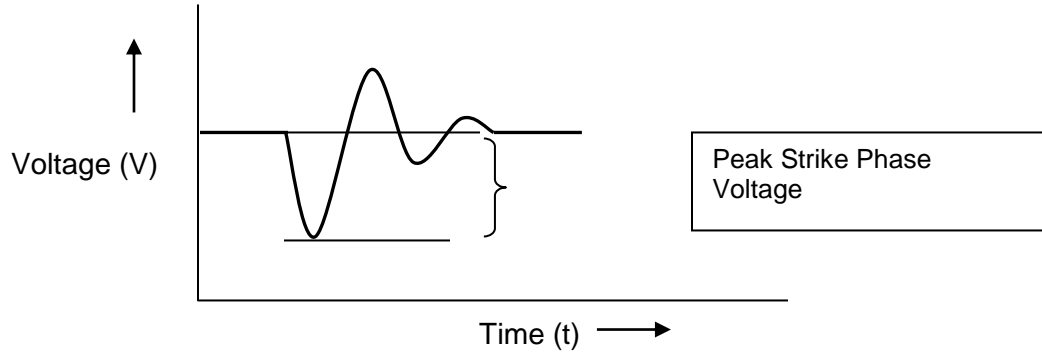

FIGURE A4: M26 PEAK STRIKE PHASE VOLTAGE AND CURRENT

A.5 Net Charge (Strike Phase Net Charge)

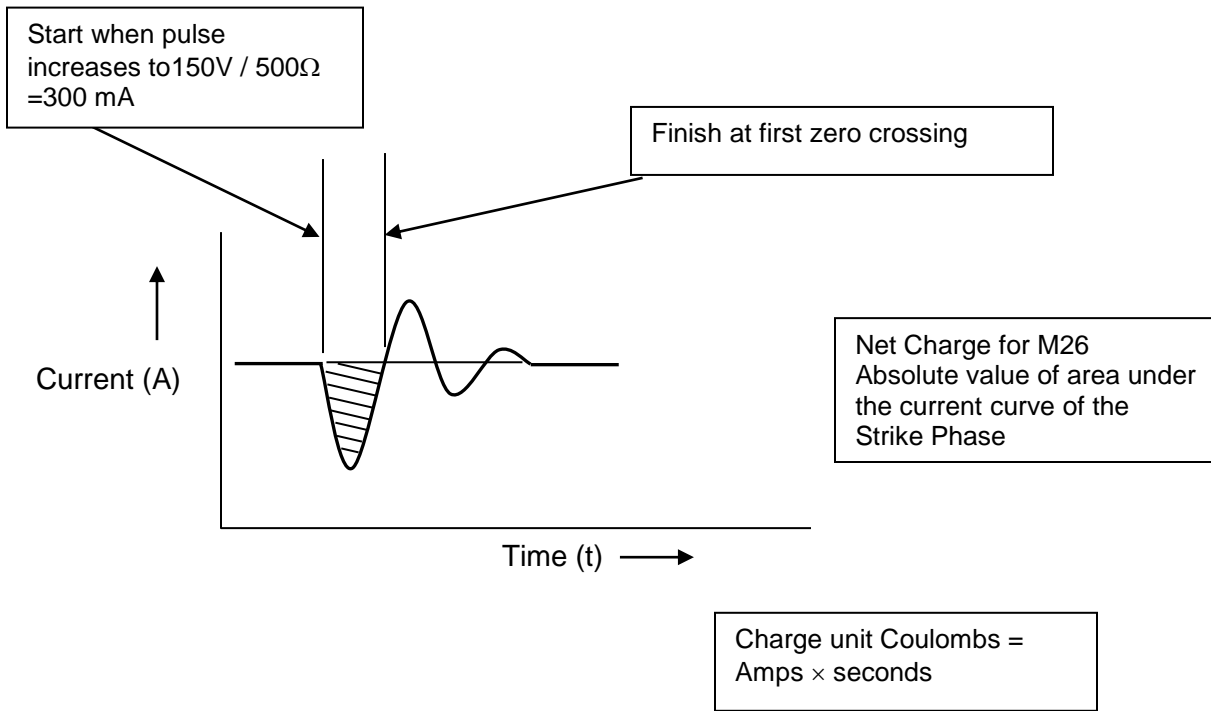

FIGURE A5: M26 STRIKE PHASE NET CHARGE

A. 6 Pulse Duration

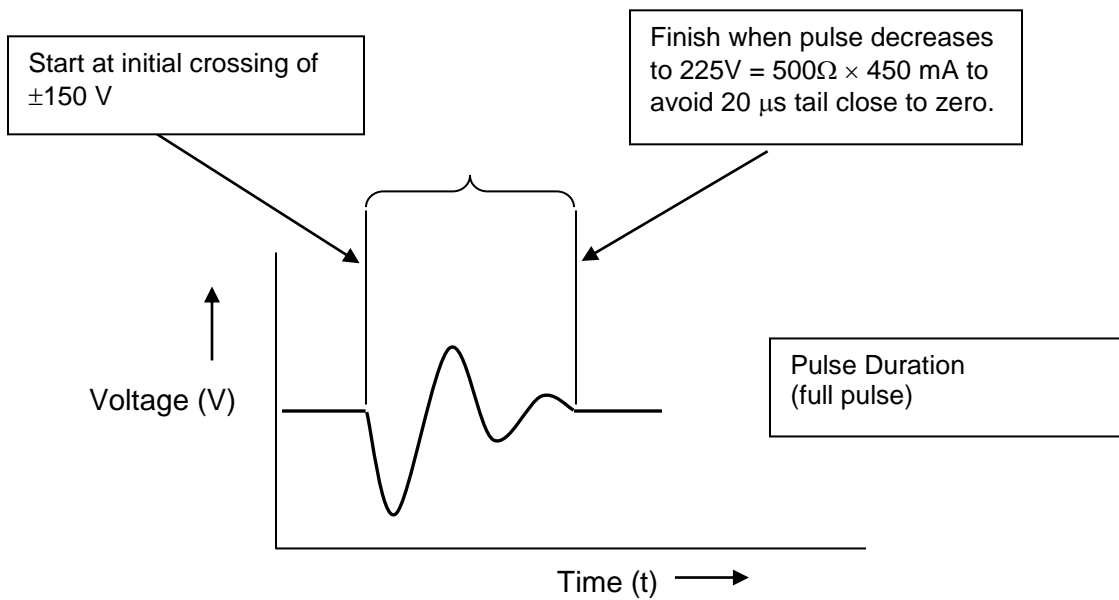

FIGURE A6: M26 FULL PULSE DURATION

A.7 Pulse Repetition Rate

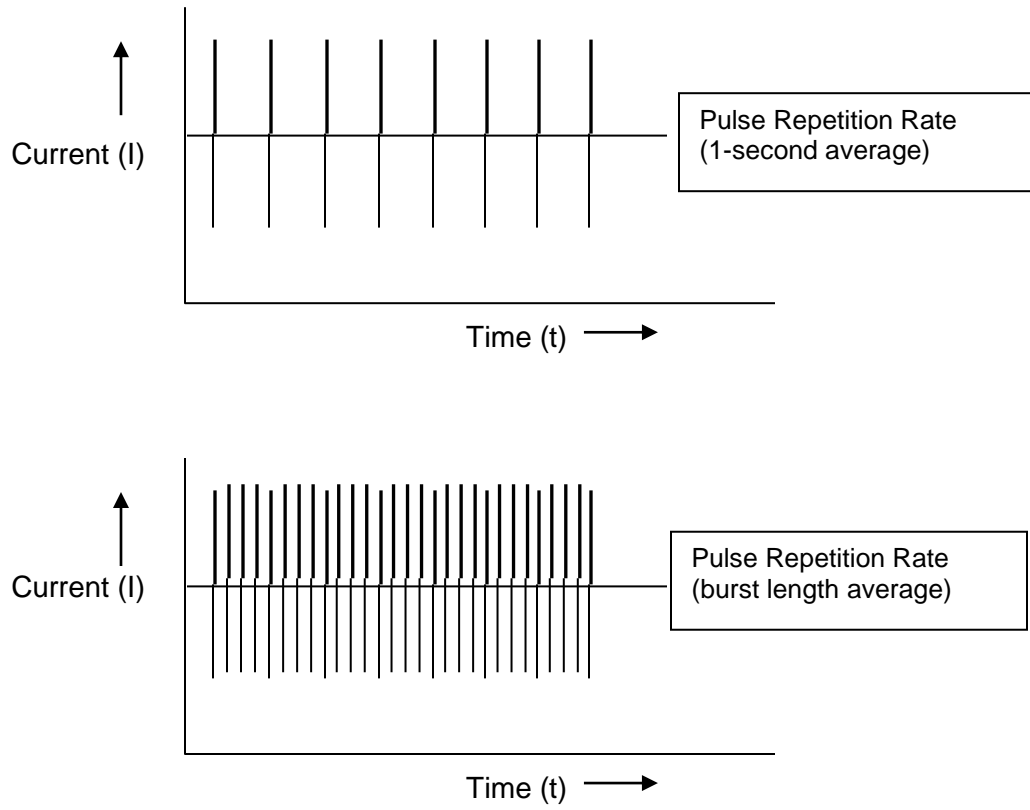

FIGURE A7: M26 PULSE REPETITION RATE

A.8 Monophasic Charge and Total Charge

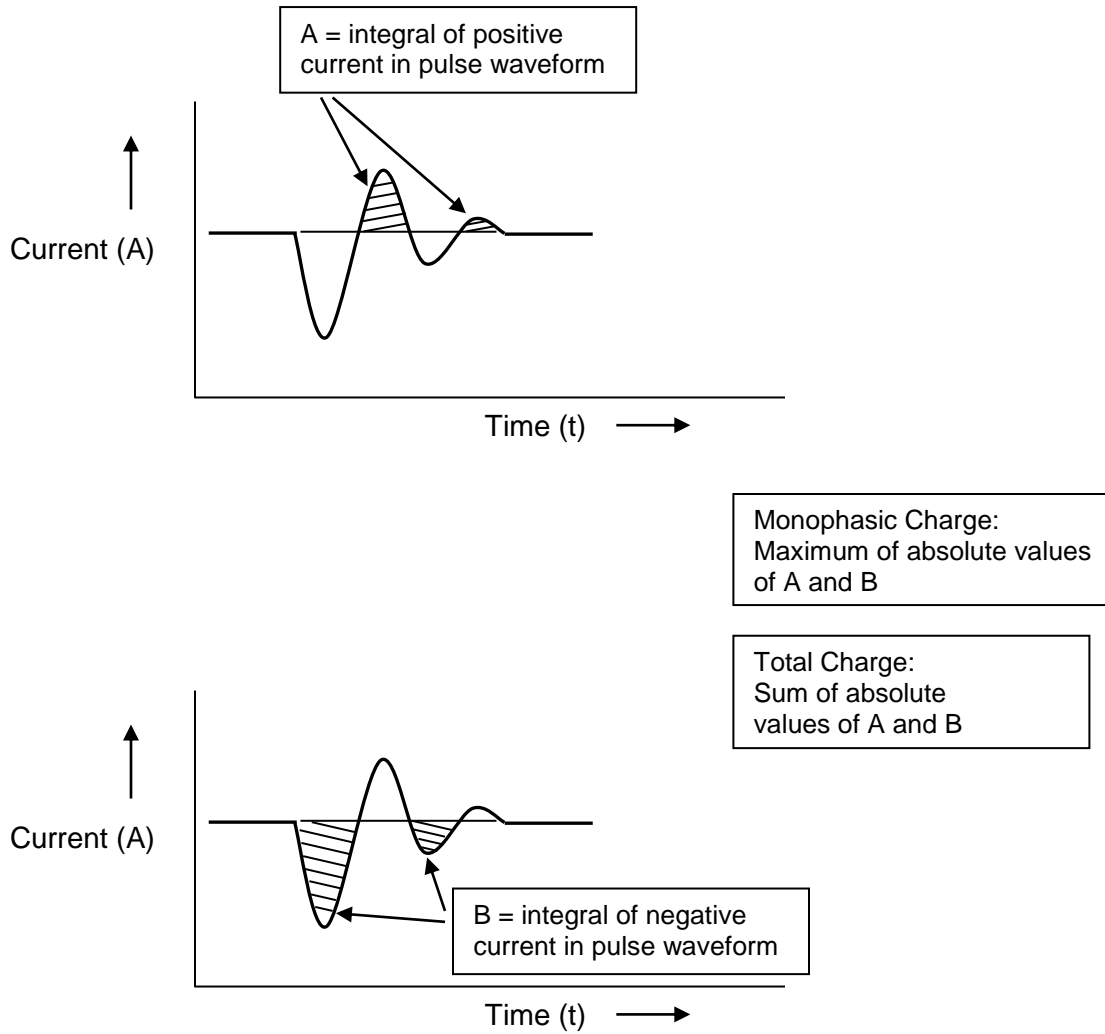

FIGURE A8: M26 MONOPHASIC CHARGE

A.9 Specifications

Advanced TASER™ M26 Electronic Control Device Specification Version 2.0, 2009-02-06 ¹ contains the following electrical specifications.

TABLE A1: TASER M26 SPECIFICATIONS AS PER TI

Item	Value
Waveform	Damped oscillation
Peak loaded voltage	6,900 to 9,400 V
Strike Phase Net Charge	70 to 120 μC
Pulse duration	32 to 60 μs
Pulse rate (NiMH rechargeable cells)	15 to 26 pulses per second
Pulse rate (alkaline cells)	11.25 to 19.5 pulses per second

Two other specifications, Strike Phase Duration and Full Pulse Net Charge are also listed in the specification, but are not included here. The values listed are taken to be sufficient for the purpose of characterizing a device.

The TI specifications call the beginning of the pulse the “Main Phase”. For the purpose of this testing and reporting, this nomenclature has been changed to “Strike Phase” in order to avoid confusion with the Main Phase of the X26 pulse.

The “Strike Phase” is both the arc-creating and current-delivering phase in the M26; the remainder of the pulse could be termed the “Decay Phase”, as it represents the pulse decay in the form of a damped sinusoid.

It is noted in the TASER documentation in part as follows:

- output specifications were derived from a 500 Ω resistive load
- output specifications may vary depending on temperature, battery charge, and load characteristics.
- Pulse rate specifications at room temperature. Temperatures below 32 F (0 C) can significantly reduce the pulse rate.

¹ Taser International, Advanced Taser M26 Series Electronic Control Device Specification Version 2, 2009-02-06, Online: http://www.ecdlaw.info/outlines/EC_02-01-09_M26-Spec.pdf

A.10 Test Details

These test details are required in order to determine whether the unit under test is operating within manufacturer's specifications. Additional test data such as maximum, minimum and average for each parameter from all pulses over all three firings should also be reported.

TABLE A2: TASER M26 SPECIFICATIONS WITH TEST CONDITIONS

Parameter	Condition	Spec into 500 Ω Load
Peak Voltage	Peak of absolute value of voltage, on a pulse averaged over the last eight pulses	6900 – 9400 V
Peak Current	Peak of absolute value of current, on a pulse averaged over the last eight pulses	13.8 – 18.8 A
Net Charge (Strike Phase Net Charge)	Area under Strike Phase current vs time curve, on a pulse averaged over the last eight pulses	70 – 120 μ C
Pulse Duration	Between initial point of waveform ¹ and final point ² , on a pulse averaged over the last eight pulses	32 – 60 μ s
Pulse Repetition Rate	Average over last second of 1 st firing - Alkaline battery - NiMH battery	15 +5/-4 pulses/s 20 +6/-5 pulses/s
Monophasic Charge* (see Note 7 on Page 10))	The maximum of the absolute values of A and B, where A = the integral of all positive current in a pulse and B = the integral of all negative current in a pulse.	< 180 μ C

- TASER International TASER M26 Specifications have been applied.
- Load resistor is 500 Ω non-inductive high voltage pulse-tolerant
- Peak current specs calculated from peak voltage: e.g. 13.8 A = 6900 V/500 Ω
- Use expended cartridge for the tests; check contacts when changed to next test unit
 - o Sparks jump across additional gaps when this part of the device is installed
 - o This simulates the actual conditions of deployment
- Carry out tests on a non-conductive surface
- Minimum digitizer resolution 75 V (corresponding to 1% of the maximum specified peak voltage)
- Raw trace data to be retained to permit further post-test analysis.
- Uncertainty calculations for instrumentation setup, as per IEC/ISO 98-3:2008 Guide to the Expression of Uncertainty in Measurement (GUM).
- * Monophasic Charge is not part of TASER International Specifications

¹ Initial point is first sample in the pulse where absolute voltage reaches 150 V with 500 Ω load

² Final point is last sample in the pulse where absolute voltage drops below 225 V with 500 Ω load

A.11 Sample Test Data

Test data to be measured/calculated during a typical test are as follows:

TABLE A3: TASER M26 CEW TEST OBSERVATION DETAILS

Parameter	Method of Measurement	Typical Values
Model Number	Device label	M-26
Serial Number	Device label	P1-009601
Battery Status	Battery usage record. Power supply voltage	< 25 discharges 12 Vdc
Lab Temperature	Thermometer in the lab	26 C
Battery Version	Battery labels. Power supply description	Duracell Ultra Fixed DC Supply
Load resistance	Multimeter	495 Ω

TABLE A4: TASER M26 CEW OPERATING PARAMETERS, TYPICAL VALUES

Parameter	Method of Measurement	Typical Values
Peak Voltage	Maximum voltage out of all samples during Strike Phase.	7400 V
Peak Current	Maximum current out of all samples during Strike Phase.	15.2 A
Net Charge (Strike Phase Net Charge)	Current at each sample of the strike phase multiplied by the time between data samples, all samples then summed up.	105 μC
Pulse Duration	Time between crossing of initial and final thresholds of the full pulse	40 μs
Pulse Repetition Rate	Number of pulses during the burst minus 1 divided by the burst length.	14.5 pps

Note that TASER International also specifies Full Pulse Net Charge and Strike Phase Duration as parameters for the M26. It is believed that Strike Phase Charge and Full Pulse Duration are the more important parameters. This also maintains consistency with the parameters measured for the X26 model.

Appendix B
Detailed Specifications
TASER X26E

Appendix B Detailed Specifications TASER X26E

B.1 Introduction

This appendix gives details of the waveform, definitions and specifications for the parameters of interest for the TASER X26E. (The weapon previously labelled X26 was designated as the X26E when the X26P was introduced.)

B.2 Pulse Waveform

The TASER X26E pulse consists of an “Arc Phase” and a “Main Phase” as shown in Figure B1. The pulses are delivered in a burst consisting of approximately 95 pulses over 5 seconds, at the rate of 19 pulses per second, as shown in Figure B2.

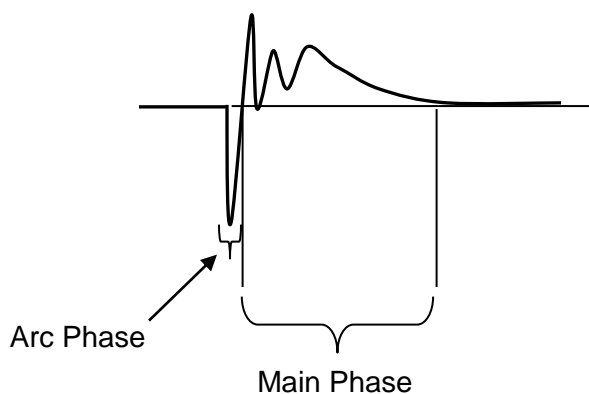

FIGURE B1: PULSE, CONSISTING OF ARC PHASE AND MAIN PHASE

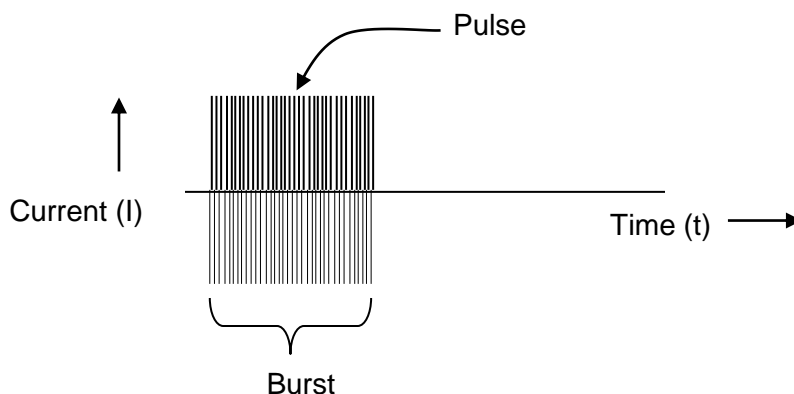

FIGURE B2: BURST OF APPROXIMATELY 95 PULSES

B.3 Parameters of Interest

Information is derived primarily from the main phase, where most of the pulse energy resides. The main phase delivers about 100 μC of charge, whereas the arc phase has only 10 μC . The purpose of the arc phase is to create an arc to allow efficient delivery of current during the main phase

The arc phase has a faster rise time and a higher peak than seen on many oscilloscopes, because of integrating effects in voltage and current probes. For this reason, measurements of the peak voltage, peak current and charge of the arc phase may be in error.

Parameters of individual X26 pulses are calculated as shown in Figure B4 to Figure B8. These describe, respectively,

- peak voltage (main phase)
- peak current (main phase)
- net charge (main phase)
- pulse duration (full pulse),
- pulse repetition rate,
- Monophasic Charge
- Total Charge

For the X26/X26E, the *Net Charge* is to be calculated over the *Main Phase*. This parameter is also known as the *Main Phase Net Charge*. (See Section B.5.)

B.4 Peak Voltage and Peak Current

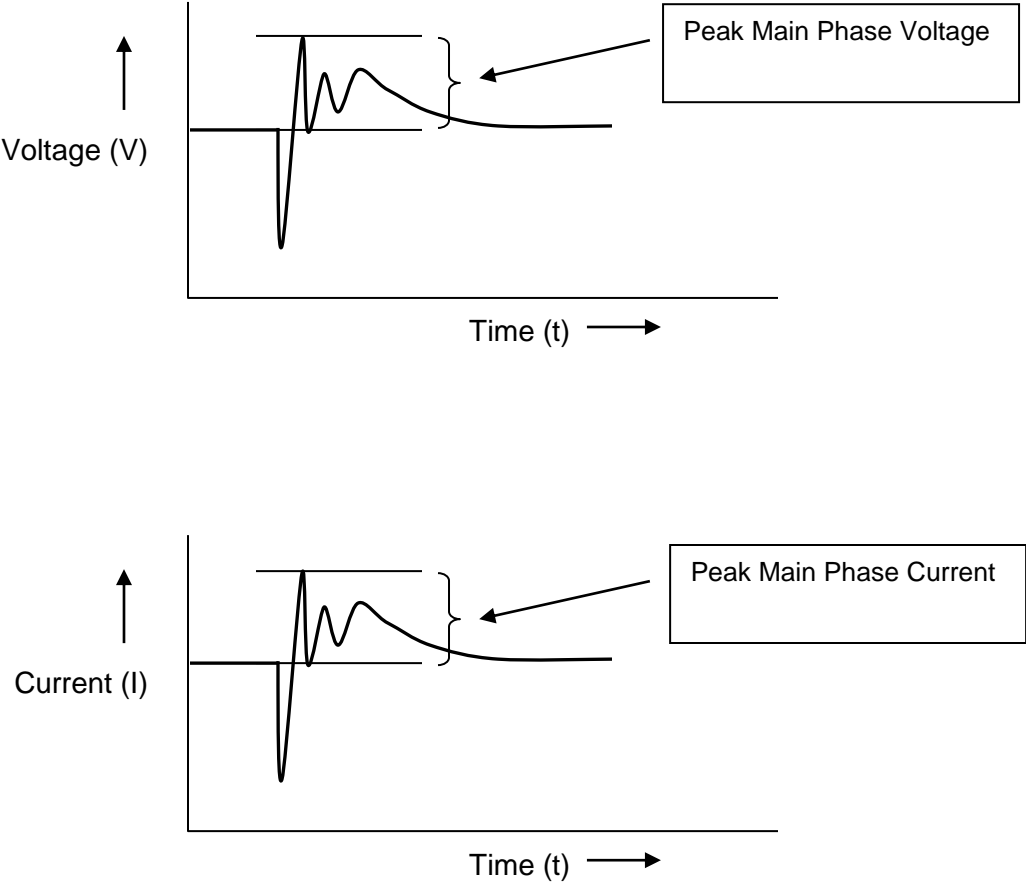

FIGURE B3: X26 PEAK MAIN PHASE VOLTAGE AND CURRENT

B.5 Net Charge (Main Phase Net Charge)

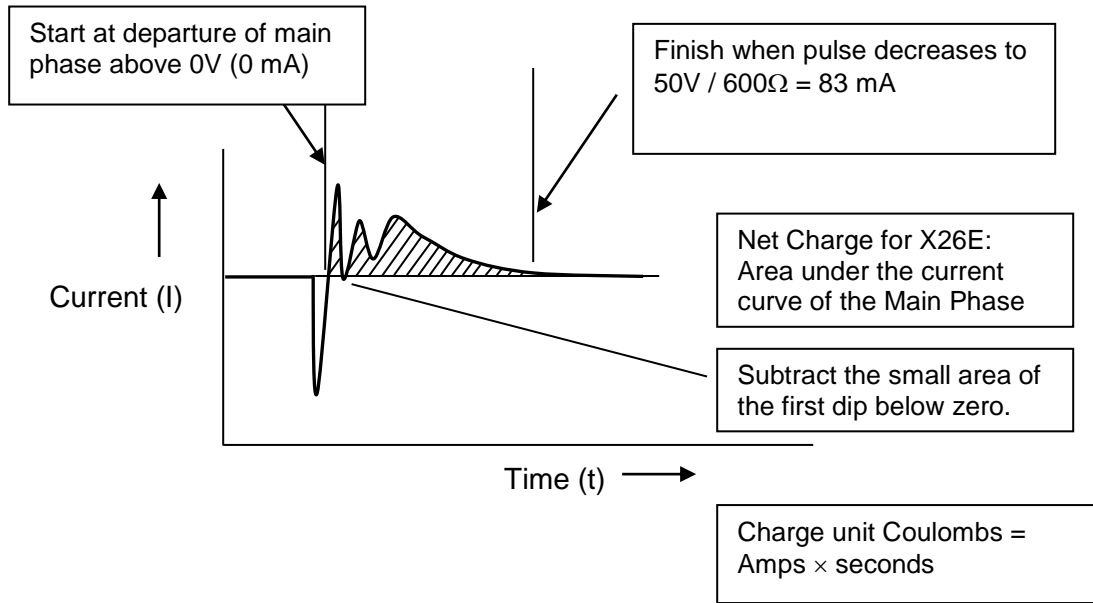

FIGURE B4: X26 MAIN PHASE NET CHARGE

B.6 Pulse Duration

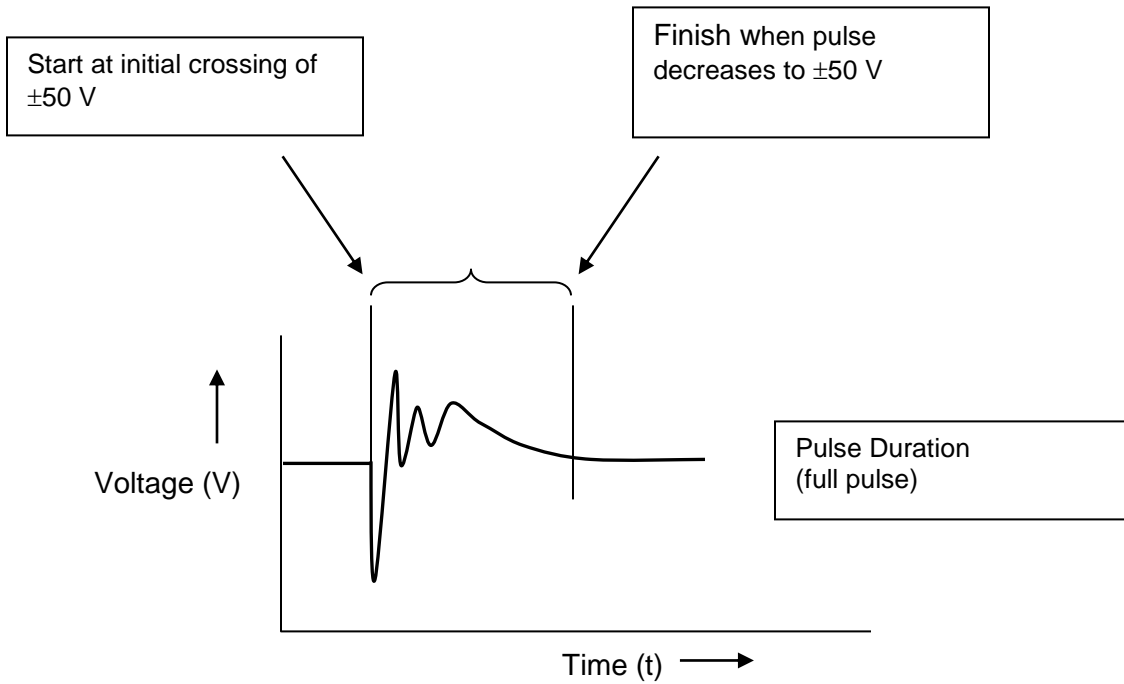

FIGURE B5: X26 PULSE DURATION

B.7 Pulse Repetition Rate

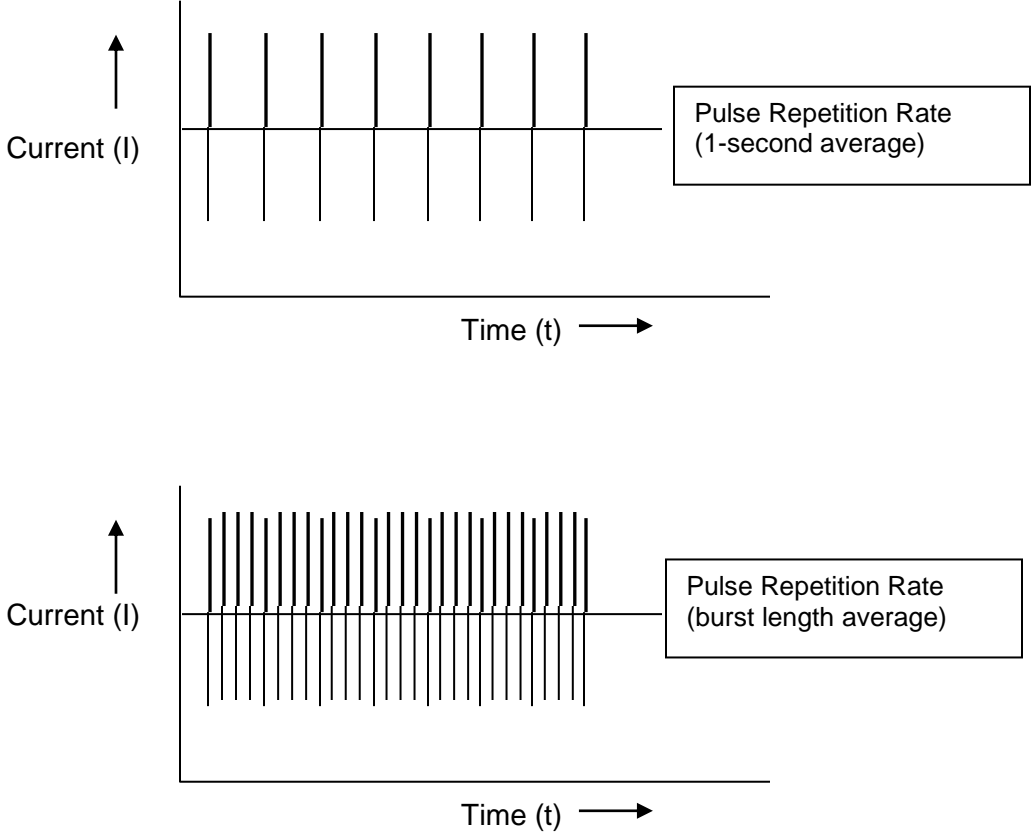

FIGURE B6: X26 PULSE REPETITION RATE

B.8 Monophasic Charge and Total Charge

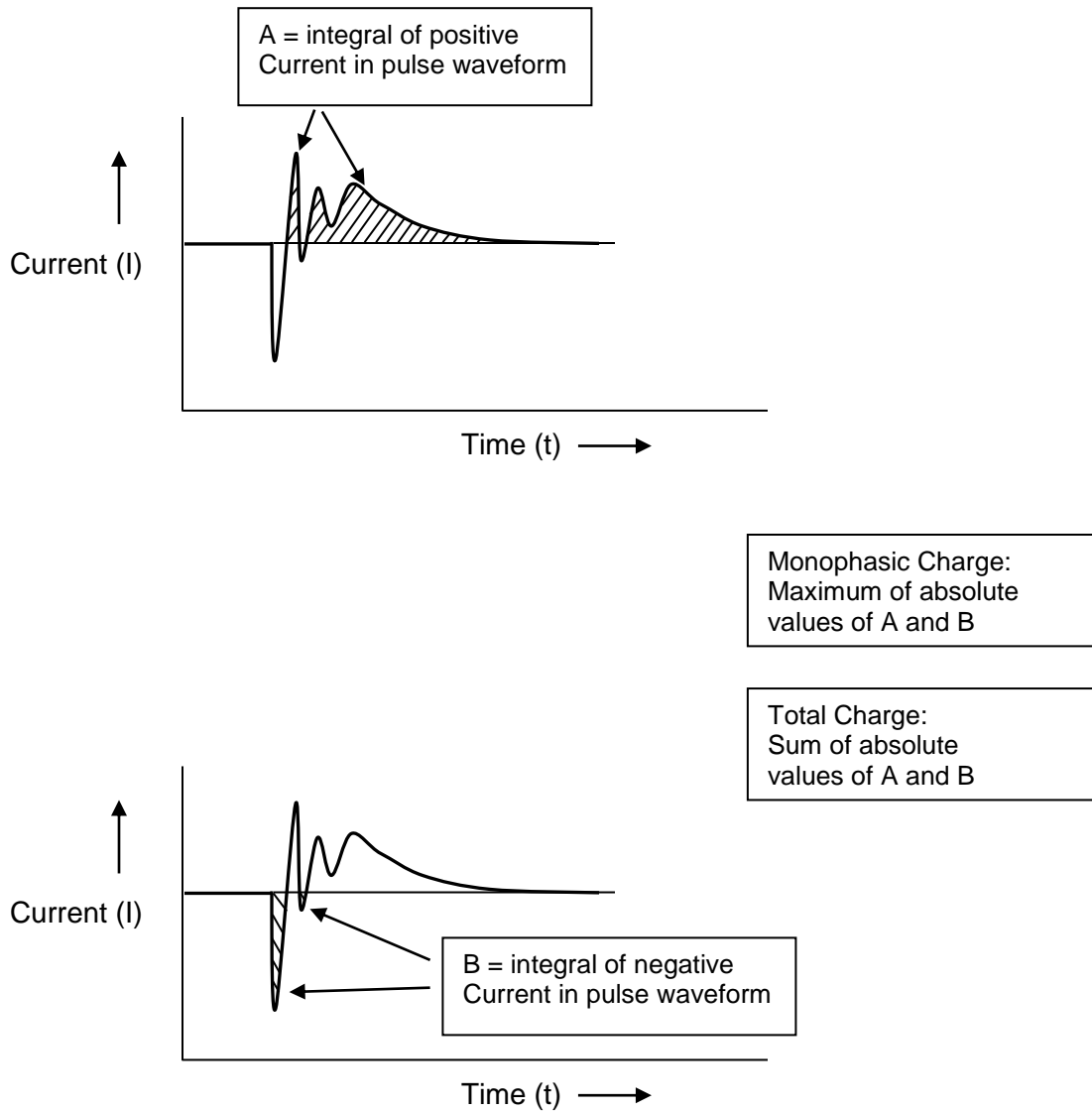

FIGURE B7: X26 MONOPHASIC CHARGE

B.9 Specifications

TASER™ X26E Series Electronic Control Device Specification Version 2.0, 2009-02-06¹ contains the following electrical specifications.

TABLE B1: TASER X26 SPECIFICATIONS AS PER TI

Item	Value
Waveform	Complex shaped pulse
Peak loaded voltage	1,400 to 2,520 V
Main Phase Net charge	80 to 125 μC
Pulse duration	105 to 155 μs
Pulse rate	16.5 to 20 pulses per second

It is noted in the TASER documentation as follows:

- output specifications were derived from a 600 Ω resistive load
- output specifications may vary depending on temperature, battery charge and load characteristics
- Pulse rate specifications are at room temperature. Temperatures below 32°F (0 C) can significantly reduce the pulse rate

¹ Taser International, Taser Electronic Control Devices Electrical Characteristics – X26, 2009-02-01, Online: www.ecdlaw.info/outlines/EC_02-01-09_%20X26_Elec_Char.pdf

B.10 Test Details

These test details are required in order to determine whether the unit under test is operating within specifications. Additional test data such as maximum, minimum and average for each parameter from all pulses over all three firings should also be reported.

TABLE B2: TASER X26 SPECIFICATIONS WITH TEST CONDITIONS

Parameter	Condition	Spec into 600 Ω Load
Peak Voltage	Peak of main phase voltage (following arc phase), on a pulse averaged over the last eight pulses	1400 – 2520 V
Peak Current	Peak of main phase current (following arc phase), on a pulse averaged over the last eight pulses	2.3 – 4.2 A
Net Charge (Main Phase Net Charge)	Area under main phase current vs time curve, on a pulse averaged over the last eight pulses	80 – 125 μC
Pulse Duration	Between initial point of waveform ¹ and final point ² on a pulse averaged over the last eight pulses	105 – 155 μs
Pulse Repetition Rate	Average over last second of 1 st firing	16.5 – 20 pps
Monophasic Charge* (see Note 7 on Page 10))	The maximum of the absolute values of A and B, where A = the integral of all positive current in a pulse and B = the integral of all negative current in a pulse.	< 180 μC

- TASER International TASER X26 Specifications have been applied.
- Load resistor is 600 Ω non-inductive
- Peak current specs calculated from peak voltage: e.g. 2.3 A = 1400 V/ 600 Ω
- Use expended cartridge for the tests; check contacts when changed to next test unit
 - o Sparks jump across additional gaps when this part of the device is installed
 - o This simulates the actual conditions of deployment
- Carry out tests on a non-conductive surface
- Minimum digitizer resolution 25 V (corresponding to 1% of the maximum peak voltage)
- Note the remaining battery capacity and software revision from the digital display. Inserting a fresh battery pack will update the unit with the latest revision software. The tests are valid for software versions 15 and greater.
- Raw trace data to be retained to permit further post-test analysis.
- Uncertainty calculations for instrumentation setup, as per IEC/ISO 98-3:2008 Guide to the Expression of Uncertainty in Measurement (GUM).
- * Monophasic Charge is not part of TASER International Specifications

¹ Initial Point is first point in the pulse where absolute voltage reaches 50 V with 600 Ω load

² Final point is last point in the pulse where absolute voltage drops below 50 V with a 600 Ω load

B.11 Sample Test Data

Test data to be measured/calculated during a typical test are as follows:

TABLE B3: TASER X26E CEW TEST OBSERVATION DETAILS

Parameter	Method of Measurement	Typical Values
Model Number	Device label	X-26
Serial Number	Device label	X00-157163
Battery Status	LED display in device	30% to 97%
CEW Temperature	LED display in device	26 C
Software Version	LED display in device	15, 18, 20, 21, 22
Battery Version	Label on the side of the DPM	21, 22, or XX if indecipherable
Load resistance	Multimeter	595 Ω

TABLE B4: TASER X26E CEW OPERATING PARAMETERS, TYPICAL VALUES

Parameter	Method of Measurement	Typical Values
Peak Voltage	Maximum voltage out of all samples during main phase.	1905 V
Peak Current	Maximum current out of all samples during main phase.	3.2 A
Net Charge (Main Phase Net Charge)	Current at each sample of the main phase multiplied by the time between data samples and summed.	105 μC
Pulse Duration	Time between crossing of initial and final thresholds of the full pulse	135 μs
Pulse Repetition Rate	Number of pulses during the burst minus 1 divided by the burst length.	17.5 pps

Appendix C
Detailed Specifications
TASER X26P and X2

Appendix C

Detailed Specifications

TASER X26P and X2

C.1 Introduction

This appendix gives details of the waveform, definitions and specifications for the parameters of interest for the TASER X26P. The TASER X2 has identical waveform specifications, but with two cartridge respectively. In practice, the X2 can have a slightly longer pulse duration, due to the smaller spark gap on the respective cartridge, but this does not change the specified values.

C.2 Pulse Waveform

The TASER X26P pulse consists of an “arc phase” and “main phase” as shown in Figure C1. The pulses are delivered in a burst consisting of approximately 95 pulses over 5 seconds, at the rate of 19 pulses per second, as shown in Figure C2.

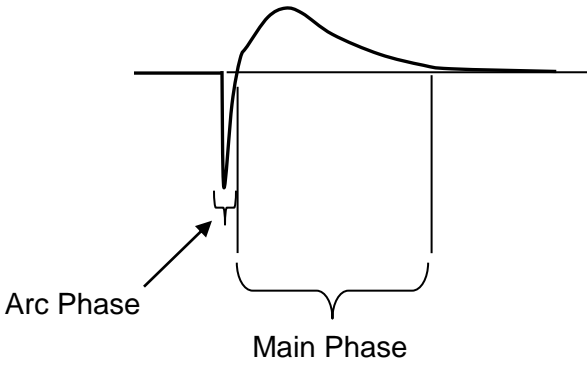

FIGURE C1: PULSE, CONSISTING OF ARC PHASE AND MAIN PHASE

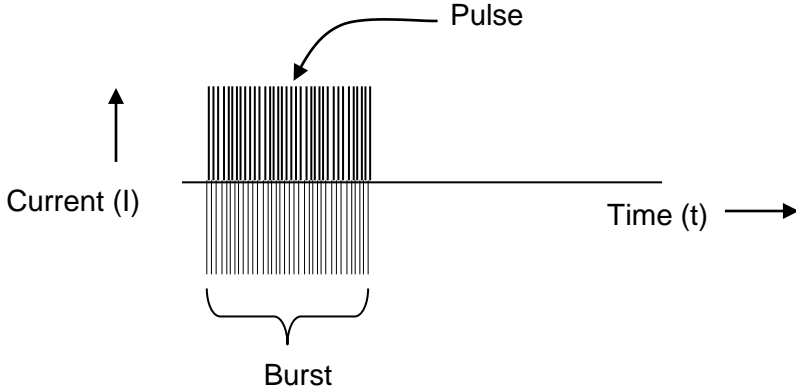

FIGURE C2: BURST OF APPROXIMATELY 95 PULSES

C.3 Parameters of Interest

Information is derived primarily from the main phase, where most of the pulse energy resides. The main phase delivers about 70 μC of charge, whereas the arc phase has only 7 μC . The purpose of the arc phase is to create an arc to allow efficient delivery of current during the main phase. Note that the full pulse net charge parameter will subtract the charge of the arc phase from the main phase, and thus will have a value of approximately 63 μC .

The arc phase has a faster rise time and a higher peak than seen on many oscilloscopes, because of integrating effects in voltage and current probes. For this reason, measurements of the peak voltage, peak current and charge of the arc phase may be in error.

Parameters of individual X26P pulses are calculated as shown in Figure C4 to Figure C8. These describe, respectively,

- peak voltage (main phase)
- peak current (main phase)
- net charge (full pulse)
- pulse duration (full pulse),
- pulse repetition rate,
- Monophasic Charge
- Total Charge

For the X26P/X2, the *Net Charge* is to be calculated over the *Full Pulse*. This parameter is also known as the *Full Pulse Net Charge*. (See Section C.5.)

C.4 Peak Voltage and Peak Current

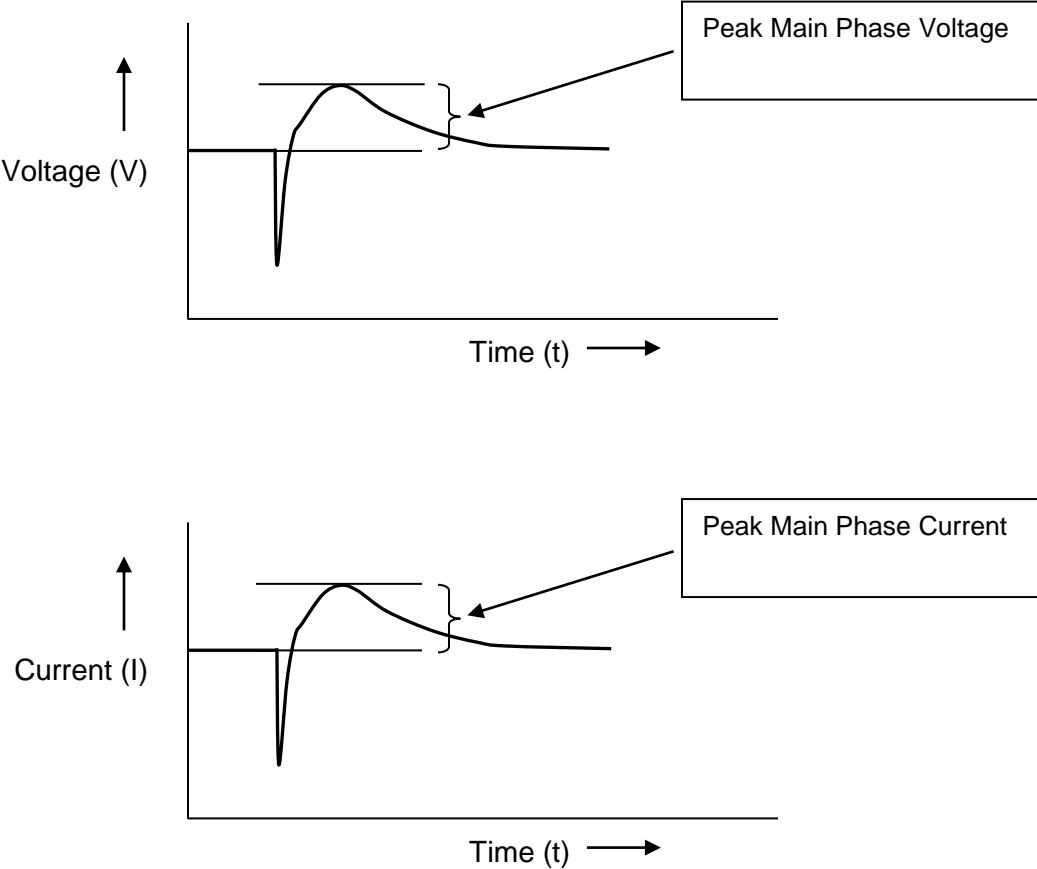

FIGURE C3: X26P PEAK MAIN PHASE VOLTAGE AND CURRENT

C.5 Net Charge (Full Pulse Net Charge)

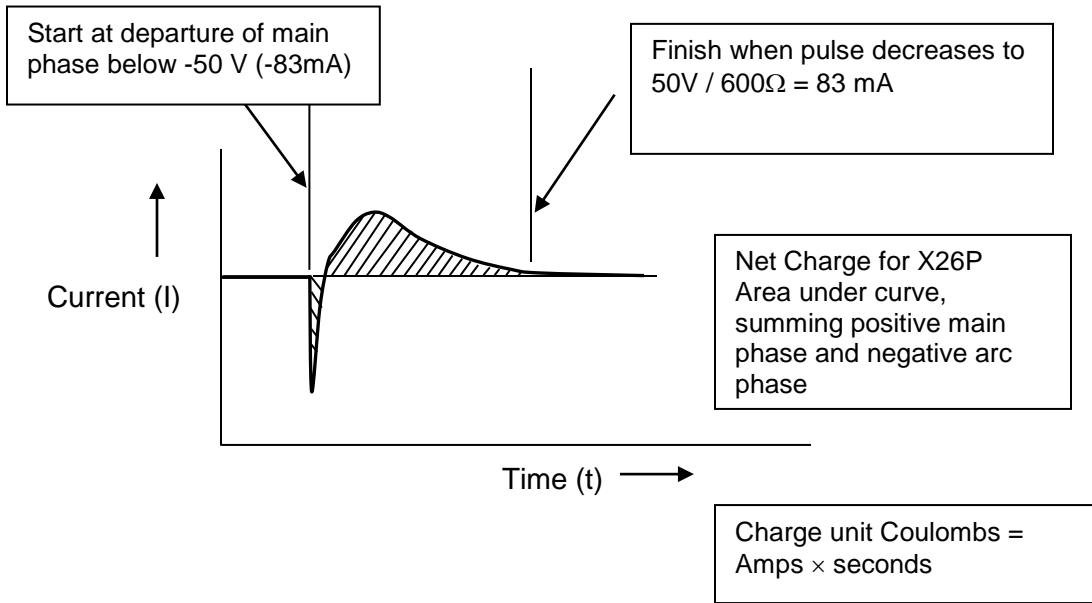

FIGURE C4: X26P FULL PULSE NET CHARGE

C.6 Pulse Duration

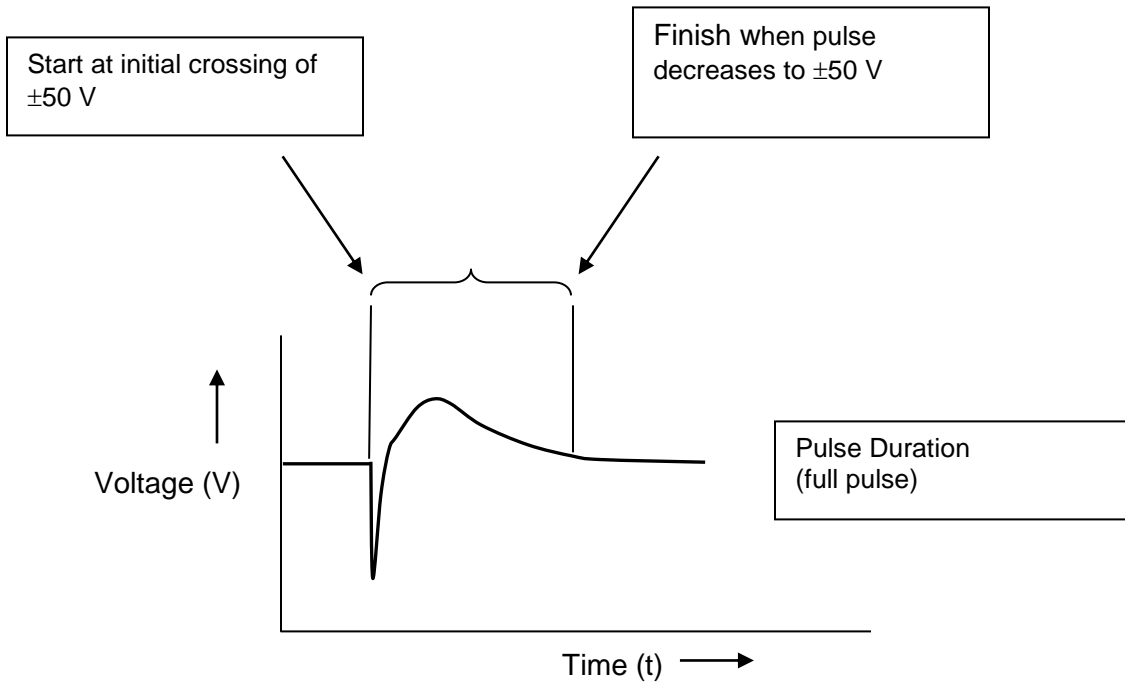

FIGURE C5: X26P PULSE DURATION

C.7 Pulse Repetition Rate

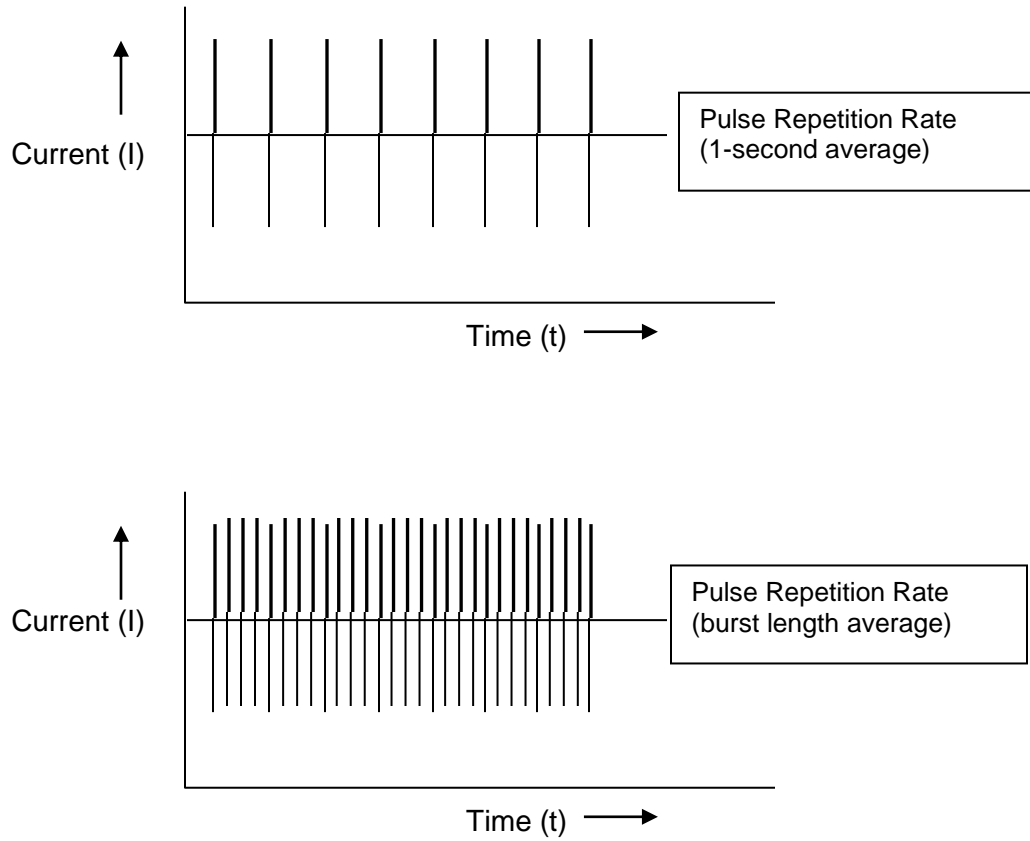

FIGURE C6: X26P PULSE REPETITION RATE

C.8 Monophasic Charge and Total Charge

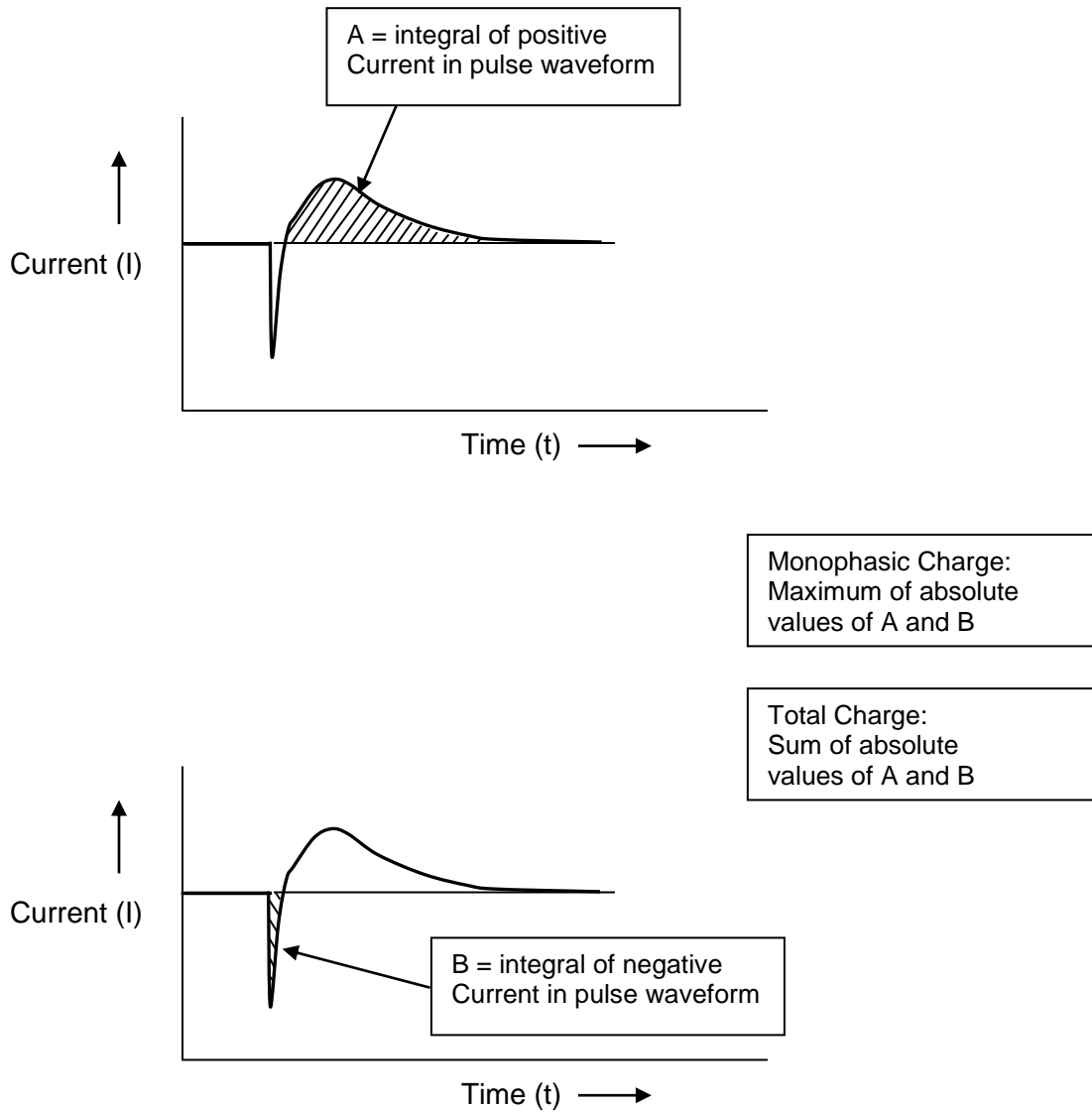

FIGURE C7: X26P MONOPHASIC CHARGE

C.9 Specifications

TASER™ X26P Series Electronic Control Device Specification Version 3.0, 2015-08-25¹ contains the following electrical specifications.

TABLE C1: TASER X26P SPECIFICATIONS AS PER TI

Item	Value
Waveform	Complex shaped pulse
Peak loaded voltage	840 to 1,440 V
Full Pulse Net Charge	54 to 72 μC
Pulse duration	50 to 125 μs
Pulse rate	18 to 20 pulses per second

It is noted in the TASER documentation as follows:

- output specifications were derived from a 600- Ω resistive load
- output specifications may vary depending on temperature, battery charge and load characteristics
- Pulse rate specifications are at room temperature. Temperatures below 32°F (0 C) can significantly reduce the pulse rate

¹ Taser International, Taser X26P Conducted Electrical Weapon Specification v3.0, 2015-08-25. This differs from v2.0 in the specification of the load, changing from 250-1000 Ω to 600 ohms. Version 2.0 may be found as follows:
Taser International, Taser X26P Conducted Electrical Weapon Specification v2.0, 2013-05-10, online: www.etis-elektrosoker.com/?download=X26P%20Spec-v2.pdf

C.10 Test Details

These test details are required in order to determine whether the unit under test is operating within specifications. Additional test data such as maximum, minimum and average for each parameter from all pulses over all three firings should also be reported.

TABLE C2: TASER X26P SPECIFICATIONS WITH TEST CONDITIONS

Parameter	Condition	Spec into 600 Ω Load
Peak Voltage	Peak of main phase voltage (following arc phase), on a pulse averaged over the last eight pulses	840 – 1440 V
Peak Current	Peak of main phase current (following arc phase), on a pulse averaged over the last eight pulses	1.4 – 2.4 A
Net Charge (Full Pulse Net Charge)	Area under <u>full pulse</u> current vs time curve, on a pulse averaged over the last eight pulses	54 – 72 μC
Pulse Duration	Between initial point of waveform ¹ and final point ² on a pulse averaged over the last eight pulses	50 – 125 μs
Pulse Repetition Rate	Average over last second of 1 st firing	18 – 20 pps
Monophasic Charge* (see Note 7 on Page 10)	The maximum of the absolute values of A and B, where A = the integral of all positive current in a pulse and B = the integral of all negative current in a pulse.	< 180 μC

- TASER International TASER X26P Specifications have been applied.
- Load resistor is 600 Ω non-inductive
- Peak current specs calculated from peak voltage: e.g. 2.4 A = 1440 V / 600 Ω
- Use expended cartridge for the tests; check contacts when changed to next test unit
 - o Sparks jump across additional gaps when this part of the device is installed
 - o This simulates the actual conditions of deployment
- Carry out tests on a non-conductive surface
- Minimum digitizer resolution 14 V (corresponding to 1% of the maximum peak voltage)
- Note the remaining battery capacity and software revision from the digital display. Inserting a fresh battery pack will update the unit with the latest revision software. The tests are valid for software versions 15 and greater.
- Raw trace data to be retained to permit further post-test analysis.
- Uncertainty calculations for instrumentation setup, as per IEC/ISO 98-3:2008 Guide to the Expression of Uncertainty in Measurement (GUM).
- * Monophasic Charge is not part of TASER International Specifications

¹ Initial Point is first sample in the pulse where absolute voltage reaches -50 V with 600 Ω load

² Final point is last sample in the pulse where absolute voltage drops below 50 V with a 600 Ω load

C.11 Sample Test Data

Test data to be measured/calculated during a typical test are as follows:

TABLE C3: TASER X26P CEW TEST OBSERVATION DETAILS

Parameter	Method of Measurement	Typical Values
Model Number	Device label	X-26P
Serial Number	Device label	X12004RY1
Battery Status	LED display in device	30% to 99%
CEW Temperature	LED display in device	23 C
Software Version	LED display in device	N/A
Battery Version	Label on the side of the DPM	X1
Load resistance	Multimeter	610 Ω

TABLE C4: TASER X26P CEW OPERATING PARAMETERS, TYPICAL VALUES

Parameter	Method of Measurement	Typical Values
Peak Voltage	Maximum voltage out of all samples during main phase.	1202 V
Peak Current	Maximum current out of all samples during main phase.	1.97 A
Net Charge (Full Pulse Net Charge)	Current at each sample of the <u>full pulse</u> multiplied by the time between data samples and summed.	69.2 μC
Pulse Duration	Time between crossing of initial and final thresholds of the full pulse	88.4 μs
Pulse Repetition Rate	Number of pulses during the burst minus 1 divided by the burst length.	19.15 pps
Monophasic Charge	The maximum of the absolute values of A and B, where A = the integral of all positive current in a pulse and B = the integral of all negative current in a pulse.	79.0 μC